

Creation 55 Rigid Acoustic: Herringbone Installation_{v1} -

CONDITIONS	SUBSTRATES	ACCESSORIES	INSTALLATION
------------	------------	-------------	--------------

LAYING CONDITIONS

SUBSTRATE EVENNESS	Flatness requirement: < 5 mm / 2 metre ruler and < 1 mm / 20 cm ruler	Flat, clean, sound, dry and solid substrate.
STORAGE	At least 24 hours prior to installation	Store the floor covering in the room where it is going to be laid.
LAYING TEMPERATURE	+ 10°C < T < + 30°C	Ideally 20°C.
PERIMETER EXPANSION GAP	8 to 15 mm	Around the edges of the room, permanent installations (e.g. columns, island stands) and door frames (8 mm minimum). Over 8 linear meters, increase progressively the perimeter expansion gap up to 15 mm for 20 linear meters. The gap must be covered by a finishing profile. Wet rooms (e.g. bathrooms): MS Polymer or PU sealant under the finishing profile.
DIVISIONS	Every 20 linear metres or surface area > 400 m ²	Each enclosed room or premises must be considered separately. Create an expansion gap : - depending on the geometry and total surface of the room - at door frames and doorways - at all existing expansion joints on the subfloor
DIRECT SUNLIGHT (SUNNY AREAS, BAY WINDOWS, SKYLIGHTS, SKYDOMES, ETC.)	Floor temperature < 60°C	Loose laying is allowed as long as the ambient temperature is regulated. In order to prevent the floor temperature from reaching excessive values up to 60°C or above, direct sunlight on the floor should be obscured by curtains, blinds or other suitable protection.
VERANDA/CONSERVATORY	Prohibited	Prohibited, irrespective of the substrate.
FIRST USE	Immediately after installation	

USAGE CONDITIONS

USAGE TEMPERATURE	+ 8°C < T < + 60°C	
STATIC LOADS	< 30 kg/cm ² and < 200 kg/support	Do not use rubber end caps. Use flat (not tapered) end caps without any pattern that are suitable for PVC. Use end caps on furniture legs.
CASTOR CHAIRS	PVC-compatible castors according to EN 12529	Recommendation: protective mat beneath castor chairs.

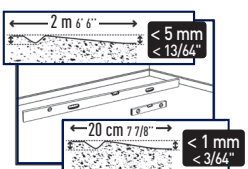

SUBSTRATE EVENNESS

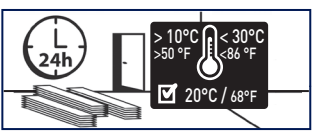

STORAGE

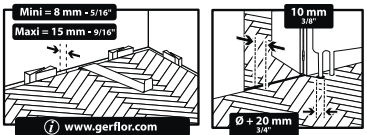

PERIMETER EXPANSION GAP

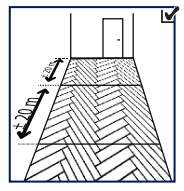

DIVISIONS

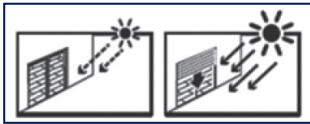

DIRECT SUNLIGHT



STATIC LOADS

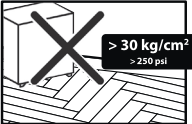

MAINTENANCE

IMPORTANT : The information in this document is valid from: 13/09/22 and is subject to change without notice. As we carry out continuous technical improvements, our customers should check with us that this document is still in force before starting any work.



Creation 55 Rigid Acoustic: Herringbone Installation_{v1} -

CONDITIONS	SUBSTRATES	ACCESSORIES	INSTALLATION
------------	-------------------	-------------	--------------

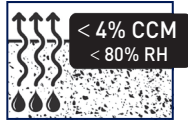
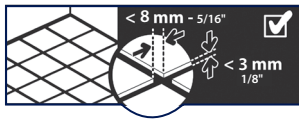
SUBSTRATE		CONDITIONS For installing this floor covering
Concrete floor, painted concrete, levelling compound, cement based screed, anhydrite (calcium sulphate)-based screed	✓	Moisture content: Cement based substrate: < 4 % CCM, 80 % RH - Anhydrite-based substrate: < 0.5 %. If necessary, prepare the support and apply a smoothing compound to eliminate any irregularities
		
Ceramic tiles	✓	If tile joints < 8 mm wide, < 3mm deep, and < 1mm unevenness. Otherwise, apply a grouting product or levelling compound
		
Glued compact PVC / rubber / linoleum floor coverings	✓	After examination and repair depending on the condition of the floor covering. If more than 10% is in bad condition, complete removal is necessary followed by new substrate preparation
Glued foam backed PVC floor coverings	!	In residential areas (premises classified CEN 23-31). After examination and repair depending on the condition of the floor covering. if more than 10% is in bad condition, complete removal is necessary followed by new substrate preparation.
Textile floor covering (carpet) / textile-backing PVC floorings	✗	Prohibited
Acoustic underlayers	✗	complete removal
Glued parquet / laminated floor /floating parquet or wood based panels	✗	Prohibited (complete removal)
OSB	!	Apply a fiber-reinforced levelling compound after treatment of any unevenness and joints between panels
Wood-based panel flooring on joists or battens / parquet nailed on battens ventilated underneath	✓	After treatment of any possible defects on the substrate (unevenness, open joints between planks or panels).
Water reversible underfloor heating	✓	Allowed
Underfloor heating with circulating water, max temperature 28°C	✓	Allowed
Radiant electric underfloor heating	✗	Prohibited

The preparation of the substrate must comply with the current relevant standards in the country of use.
For any information on product properties and usages, please refer to its technical datasheet: www.gerflor.com.

Creation 55 Rigid Acoustic: Herringbone Installation_{v1} -

CONDITIONS	SUBSTRATES	ACCESSORIES	INSTALLATION
------------	------------	--------------------	--------------

TOOLS	Cutter - Tape measure - Metal ruler - false square Non rebound mallet : Romus Ref. 94964 - Tapping block - Pull bar Mitre shears : Romus Ref. 93401 / Janser Ref. 237 530 000
FINISHES	Design skirting Ref. 6086 / MDF design skirting Ref. 5947 - See installation guidelines [504A] and [504B]. Multifunctional threshold: design coverstrip Ref. 0647. Rooms exposed to water (e.g. bathrooms): MS Polymer or PU sealant.

Creation 55 Rigid Acoustic: Herringbone Installation_{v1} -

CONDITIONS

SUBSTRATES

ACCESSORIES

INSTALLATION



The floor covering should be examined prior to installation for any visible defects. The flooring must belong to the same production batch. If there are any visible defects, please notify GERFLOR and do not begin installation without its prior approval.

LAYOUT

- The installation starts on the wall opposite the main entrance by positioning the triangles that form the beginning of each row. Each triangle is made up of 6 planks, 3 left planks and 3 right planks.

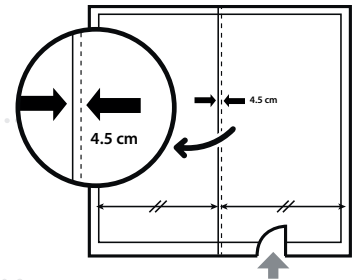

- Draw the axes required for the installation, according to the diagram opposite:
 - Draw the central axis of room
 - Draw the working axis = axis parallel to the central axis, 4.5 cm to the right of it.

- Perimeter expansion gap 8 to 15 mm : at room edges, fixed and permanent installations (e.g. columns, island stands) and door threshold (8 mm minimum. Over 8 linear meters, increase progressively the perimeter expansion gap up to 15 mm for 20 linear meters). The gap must be covered by a finishing profile. Heavy equipments (kitchen elements, shelves) should be installed before the flooring, and the expansion gap must be respected around the equipment's base or feet.

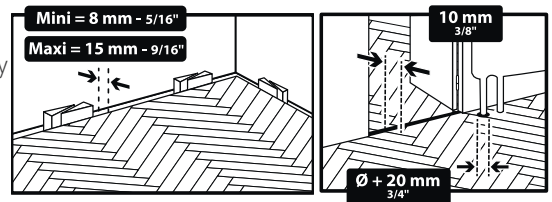

Rooms exposed to humidity (e.g. bathrooms): MS Polymer or PU sealant under the finishing profile and along the water points (bath, shower tray, toilets).

CONSTRUCTION AND INSTALLATION OF THE STARTING TRIANGLES SET

- Take the planks and the cutting template out of the box. Take care not to mix the right and left planks (R and L marking on the reverse side)

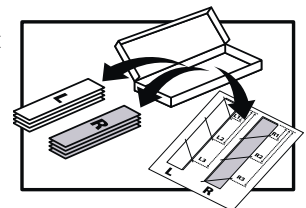

- Using a utility knife, cut three right planks and three left planks according to the template, in order to obtain plank pieces L1, L2, L3 and R1, R2, R3

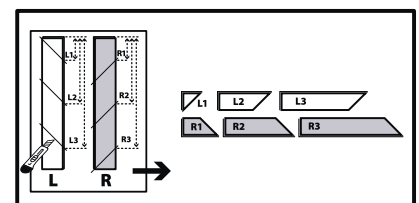

- Interlock the planks together in the order L1/R1/L2/R2/L3/R3 to form the triangle. If necessary, finish the interlocking using a tapping block and an anti-rebound mallet

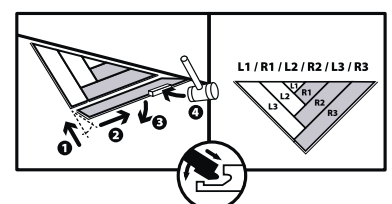

IMPORTANT : The information in this document is valid from: 13/09/22 and is subject to change without notice. As we carry out continuous technical improvements, our customers should check with us that this document is still in force before starting any work.

Gerflor

Creation 55 Rigid Acoustic: Herringbone Installation_{v1} -

CONDITIONS

SUBSTRATES

ACCESSORIES

INSTALLATION

- Place this triangle against the starting wall, respecting the perimeter expansion gap, and position the top of the triangle precisely on the working axis.

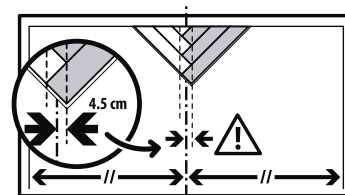

- Make new triangles, and place them on either side of this first triangle to complete the row

- At the ends of the row, cut the triangles to the required dimensions: draw the dimensions A and B on a whole triangle and then cut out with a utility knife. Disassemble the planks to cut them and then interlock them again. Depending on the dimensions, one or two whole triangles may be required. Make sure that the space around the edges is respected.

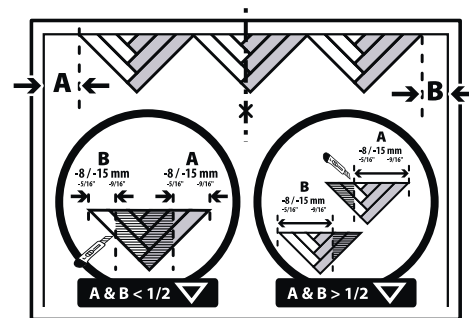

Installation of following rows

- Continuing the installation: first lay all the left planks in a row, then all the right planks.

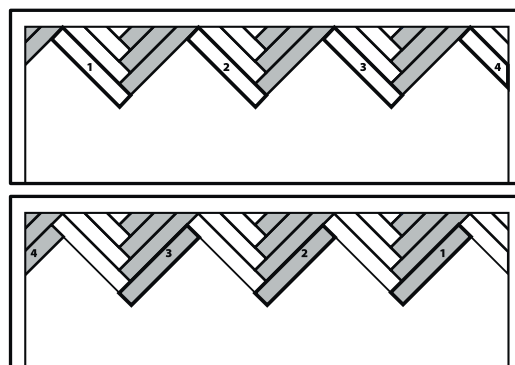

- Make sure that there is no unevenness between planks. Incorrect interlocking may lead to imperfect alignment. If necessary, re-adjust the alignment using a tapping block and a non-rebound mallet.

- Cutting at the ends of the rows, according to the scheme opposite:
 - Measure dimension C and transfer it to the plank to be cut, respecting the perimeter expansion gap
 - Use a false square to transfer the required angle precisely
 - Cut the plank at this angle with a utility knife

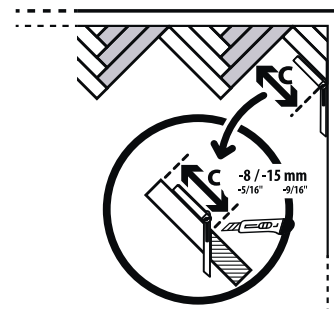

- To assemble the last row, use a pull bar and a non-rebound mallet.